

# IISDOO®

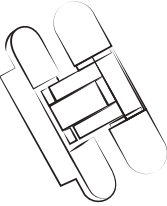

2026  
YOUR IISDOO  
**HARDWARE.**

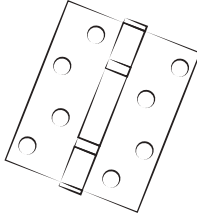

# ABOUT

@ iisdoodesign

# IISDOO

IISDOO — Precision Craftsmanship, Redefining Standards in Door Control Hardware.

Founded in 2009, IISDOO is a modern, integrated manufacturer specializing in the research & development, design, production, sales, and service of door control hardware. Our factory is located in Jiangmen, Guangdong, China, spanning an area of 10,000 square meters. It is equipped with advanced fully automated production lines, precision die-casting equipment, and digital machining centers.

We are dedicated to providing global clients with comprehensive, high-quality door hardware solutions. Our product portfolio includes:

Architectural Door Lock Series: Smart Locks, Mechanical Locks, and Commercial/Project Door Locks (suitable for wooden doors, glass doors, narrow-frame glass doors, hidden doors, etc.).

**Door Hardware Series: Hinges, Door Handles, Door Closers, Floor Springs, Door Stops, and Sliding Door Systems.**

Accessory Hardware: Door Bolts, Latches, Glass Door Clamps, and more.

Guided by the philosophy of "Quality as Foundation, Innovation as Drive," IISDOO rigorously implements the ISO 9001 Quality Management System. We have established a full-process quality traceability system, covering everything from raw material inspection and production control to finished product shipment. Our products not only meet national standards but are also exported to over 100 countries and regions, including Europe, America, Japan, South Korea, and Southeast Asia. We are proud to be a long-term designated supplier for numerous renowned real estate developers, hotel management groups, and door & window manufacturers. Committed to exceptional craftsmanship and forward-thinking design, IISDOO is dedicated to being your most trusted partner in creating secure, elegant, and seamless spatial experiences.





YOUR IISDOO  
HARDWARE

# PACKAGING



YOUR IISDOO  
HARDWARE



(PC) Polished Chrome



(GP) Polished Gold



(SBN) Satin Black Nickel



(MSN) Matt Satin Nickel



(MSC) Matt Satin Chrome



(22K MG) 22K Matt Gold



(BLK) Matt Black

At IISDOO, we unite advanced craftsmanship with aesthetic innovation through a complete range of surface treatment technologies. Utilizing sophisticated processes including Electroplating, Painting, Oxidation, and PVD (Physical Vapor Deposition), we achieve a seamless fusion of color and metal, enhancing both durability and visual elegance.

Our extensive color palette offers more than 18 refined finishes, allowing you to tailor every detail to your design vision. Available selections include: Polish Chrome, Matt Black, Brushed Brass, 22k Matt Gold, Silver, Matt White and many more...

Each finish is applied with precision to ensure resistance to corrosion, wear, and fading—making our hardware not only beautiful but also built to last. Whether for residential, commercial, or hospitality projects, our finishes meet global standards and adapt to varied architectural styles.

Choose IISDOO to bring refined aesthetics and reliable performance to every door system.



YOUR IISDOO  
**HARDWARE**

# No.1

## **WOODEN DOORS HARDWARE SERIES /**

Where Natural Material Meets Precision Craftsmanship

For years, IISDOO has stood at the intersection of traditional woodworking and precision engineering. As an integrated manufacturer with our own factory and mature expertise forged in the hardware industry, we understand that the perfect door deserves more than just functional components—it deserves a defining accent.

Our Wooden Door Hardware Series is the culmination of this experience, trusted by professionals across 42 countries. From minimalist locks and smart locks to precision hinges and durable door stops, every piece in our comprehensive collection is meticulously crafted in-house to harmonize sturdy, reliable metal with the warm, organic texture of wood. We enhance both the tactile and visual integrity of your wooden doors, ensuring seamless integration whether your vision leans toward modern minimalist clarity or rustic, classic charm. With IISDOO, you're not just selecting hardware; you're choosing the confidence that comes from decades of specialized knowledge and global recognition.



WOOD DOORS  
**LOCKS / HINGES**

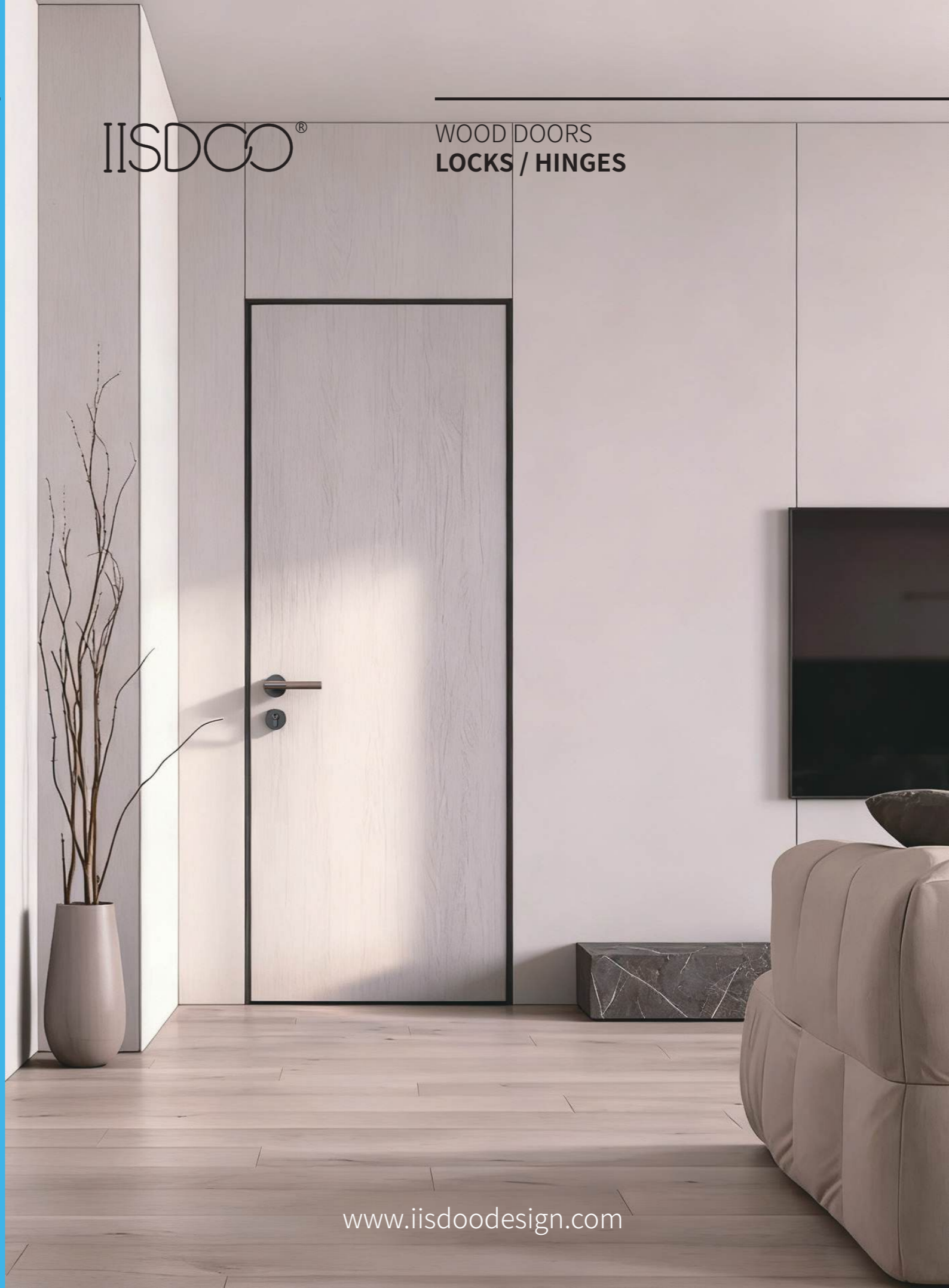

[www.iisdoodesign.com](http://www.iisdoodesign.com)



YOUR IISDOO  
HARDWARE

# Series Features

Purpose-Built for Wood: Engineered with the characteristics of wood in mind, our hardware offers precise installation and surface-friendly protection to preserve and enhance your door's material.

Rich Surface Finishes: Choose from a range of premium finishes including Polished Chrome, Matt Black, Brushed Brass, 22K Matt Gold, and Silver—achieved through advanced electroplating, PVD, and coating techniques. Each finish is curated to pair perfectly with wood grains and paints such as walnut, oak, and cherry.

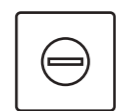
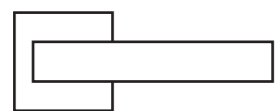

**Square** Rosette

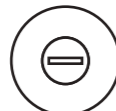
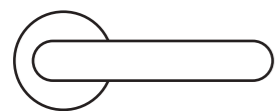

**Round** Rosette



WOOD DOORS  
LOCKS / HINGES



5mm



10mm

Quality at the Core: Staying true to the IISDOO philosophy of “Quality as Foundation, Innovation as Drive,” every product undergoes rigorous testing to ensure long-term reliability and consistent performance with wooden doors.

A Perfect Finish for Every Grain

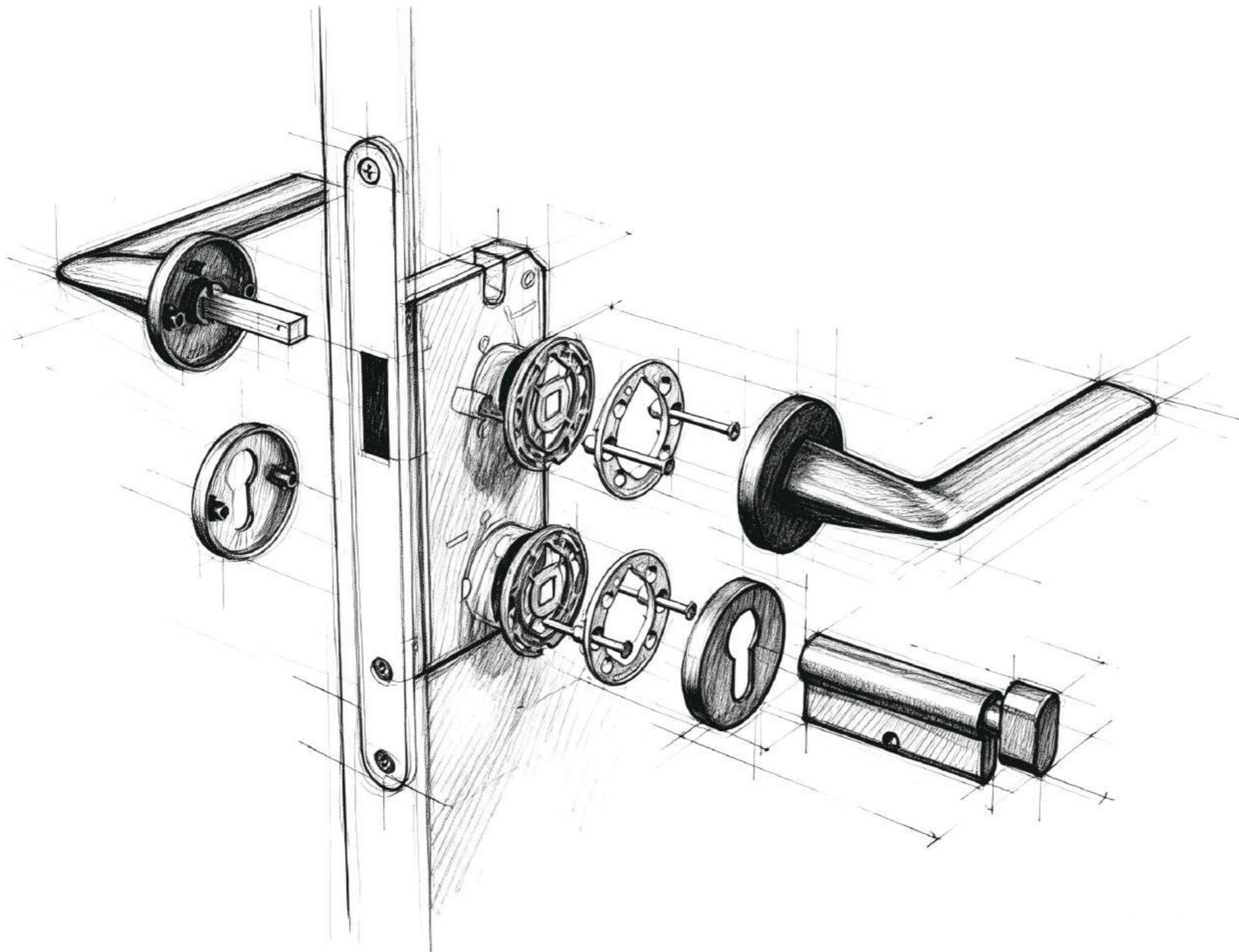

At IISDOO, we focus on the foundational details. Our Dual-Rosette System offers two engineered solutions for the structural base of door handles, catering to distinct aesthetic and functional requirements.

- Slim-Profile Rosette: Designed for a sleek, ultra-flush fit. It allows the handle to sit closer to the door surface, creating a seamless, modern aesthetic ideal for minimalist and high-end designs.
- Reinforced Thick Rosette: Built for maximum durability in high-traffic areas. Its robust construction provides superior load-bearing capacity, ensuring long-term security and steadfast performance.

Choose the precision that matches your project's demand for elegance or endurance

At IISDOO, we engineer the critical components that define a door's integrity and movement—focusing on the secure core and the seamless pivot.

1. The Secure Core: Dual-Material Lock Cylinder  
Our lock cylinders combine zinc alloy and stainless steel for a balance of design freedom and enduring strength. The zinc alloy allows for diverse, intricate shapes to match any aesthetic, while the embedded stainless steel core provides superior resistance to corrosion, wear, and tampering.

2. The Pivot Point: 15 Years as a Hinge Specialist  
For 15 years, our dedicated hinge factory has focused on perfecting door movement. Building on this expertise, in 2026 we will expand our portfolio with advanced Hydraulic Hinges for controlled closing and Concealed Hinges for a minimalist, seamless look..

IISDOO®

YOUR IISDOO  
HARDWARE



IISDOO®

WOOD DOORS  
LOCKS / HINGES



Matt Satin Nickel



Matt Black

84204

**Material:** Zinc alloy  
**Suitable door thickness:** 35-45mm  
**Available Finishes:**

   
Matt Satin Nickel    Matt Black

**Product dimensions**

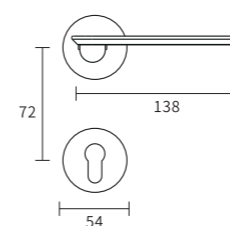

**Different configuration options**



WC escutcheon  
● 6x6mm ● 8x8mm



Yale escutcheon



Key escutcheon



YOUR IISDOO  
HARDWARE



Polished Chrome



Matt Black



WOOD DOORS  
LOCKS / HINGES



## 84205

**Material:** Zinc alloy  
**Suitable door thickness:** 35-45mm  
**Available Finishes:**



### Product dimensions

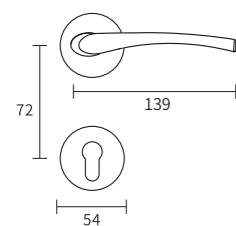

### Different configuration options



WC escutcheon  
● 6x6mm ● 8x8mm



Yale escutcheon



Key escutcheon



YOUR IISDOO  
HARDWARE



Matt Satin Nickel



Matt Black



WOOD DOORS  
LOCKS / HINGES



89206

**Material:** Zinc alloy  
**Suitable door thickness:** 35-45mm  
**Available Finishes:**

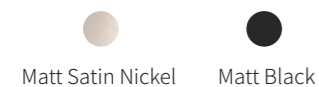

**Product dimensions**

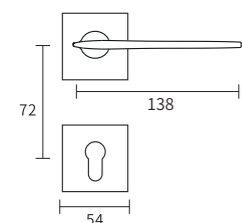

**Different configuration options**



WC escutcheon  
■ 6x6mm ■ 8x8mm



Yale escutcheon



Key escutcheon



YOUR IISDOO  
HARDWARE



Matt Satin Nickel

Matt Black



WOOD DOORS  
LOCKS / HINGES



# 84208

**Material:** Zinc alloy  
**Suitable door thickness:** 35-45mm  
**Available Finishes:**

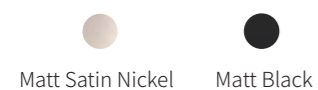

Matt Satin Nickel    Matt Black

### Different configuration options



WC escutcheon  
● 6x6mm   ● 8x8mm



Yale escutcheon



Key escutcheon

### Product dimensions

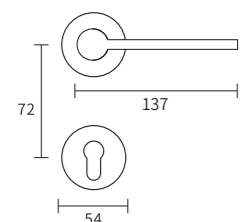



YOUR IISDOO  
HARDWARE



Matt Satin Chrome



Matt Black



WOOD DOORS  
LOCKS / HINGES

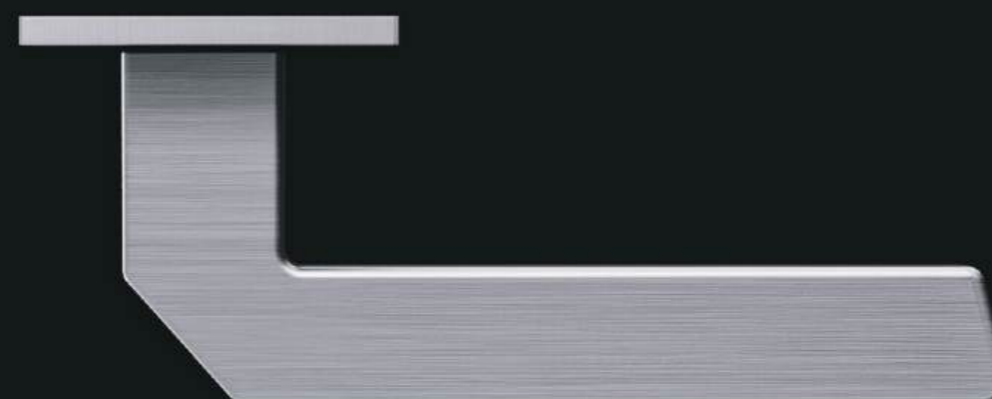
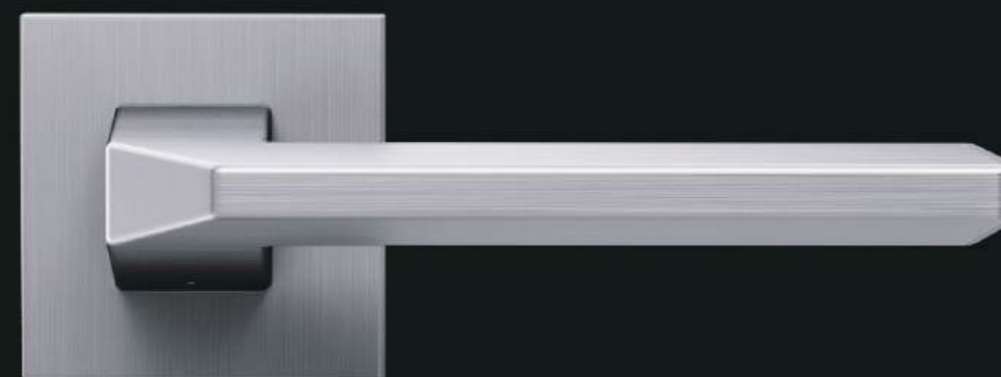

89222

**Material:** Zinc alloy  
**Suitable door thickness:** 35-45mm  
**Available Finishes:**

   
Matt Satin Chrome Matt Black

**Different configuration options**



WC escutcheon  
■ 6x6mm ■ 8x8mm



Yale escutcheon



Key escutcheon

**Product dimensions**

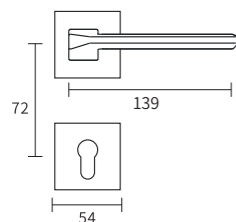



YOUR IISDOO  
HARDWARE



Polished Chrome



WOOD DOORS  
LOCKS / HINGES



84223

**Material:** Zinc alloy  
**Suitable door thickness:** 35-45mm  
**Available Finishes:**

 Polished Chrome

**Different configuration options**



WC escutcheon  
● 6x6mm ● 8x8mm



Yale escutcheon



Key escutcheon

**Product dimensions**

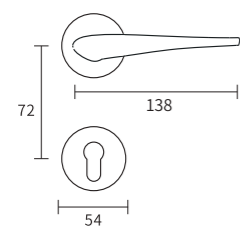



YOUR IISDOO  
HARDWARE



WOOD DOORS  
LOCKS / HINGES



Matt Satin Nickel



Matt Black

**Different configuration options**

**89231**

**Material:** Zinc alloy  
**Suitable door thickness:** 35-45mm  
**Available Finishes:**

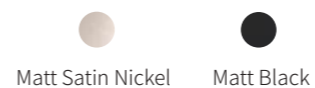

Matt Satin Nickel    Matt Black



WC escutcheon  
■ 6x6mm    ■ 8x8mm



Yale escutcheon

**Product dimensions**

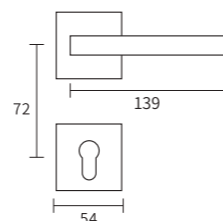

Key escutcheon



YOUR IISDOO  
HARDWARE



Matt Satin Nickel



Matt Black



WOOD DOORS  
LOCKS / HINGES



Matt Satin Nickel



Matt Black

84232

Different configuration options

Material: Zinc alloy  
Suitable door thickness: 35-45mm  
Available Finishes:

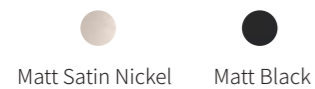

WC escutcheon  
● 6x6mm ● 8x8mm



Yale escutcheon



Key escutcheon

Product dimensions

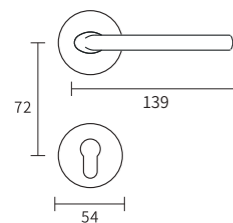

89233

Different configuration options

Material: Zinc alloy  
Suitable door thickness: 35-45mm  
Available Finishes:



WC escutcheon  
■ 6x6mm ■ 8x8mm



Yale escutcheon



Key escutcheon

Product dimensions

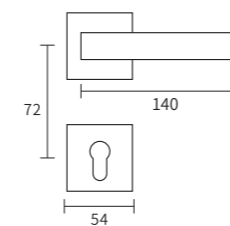



YOUR IISDOO  
HARDWARE



Polished Chrome & Satin Black Nickel

Matt Black



WOOD DOORS  
LOCKS / HINGES



Matt Black & Satin Black Nickel

# 75229

**Material:** Zinc alloy  
**Suitable door thickness:** 35-45mm  
**Available Finishes:**



**Different configuration options**



WC escutcheon  
● 6x6mm ● 8x8mm



Yale escutcheon



Key escutcheon

**Product dimensions**

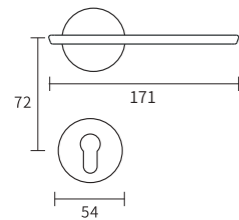

# 89243

**Material:** Zinc alloy  
**Suitable door thickness:** 35-45mm  
**Available Finishes:**



**Different configuration options**



WC escutcheon  
■ 6x6mm ■ 8x8mm



Yale escutcheon



Key escutcheon

**Product dimensions**

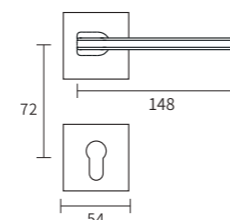



YOUR IISDOO  
HARDWARE



WOOD DOORS  
LOCKS / HINGES



Matt Satin Chrome

Matt Black

## 89241

**Material:** Zinc alloy  
**Suitable door thickness:** 35-45mm  
**Available Finishes:**

● Matt Satin Chrome    ● Matt Black

### Different configuration options



WC escutcheon  
■ 6x6mm    ■ 8x8mm



Yale escutcheon

### Product dimensions

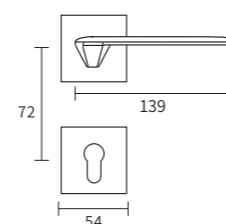

Key escutcheon



Matt Satin Nickel



Matt Satin Nickel



Matt Black



# 84249

**Material:** Zinc alloy  
**Suitable door thickness:** 35-45mm  
**Available Finishes:**



Matt Satin Nickel Matt Black

### Different configuration options



WC escutcheon  
● 6x6mm ● 8x8mm



Yale escutcheon



Key escutcheon

### Product dimensions

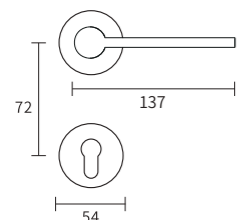



YOUR IISDOO  
HARDWARE



Satin Black Nickel



WOOD DOORS  
LOCKS / HINGES



Satin Black Nickel  
Matt Satin Nickel



Matt Black  
22K Matt Gold

## 84245

Different configuration options

Material: Zinc alloy  
Suitable door thickness: 35-45mm  
Available Finishes:



Satin Black Nickel



WC escutcheon

● 6x6mm ● 8x8mm



Yale escutcheon



Key escutcheon

Product dimensions

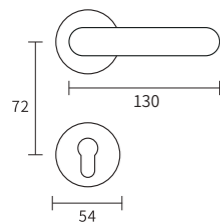

## 89269

Different configuration options

Material: Zinc alloy  
Suitable door thickness: 35-45mm  
Available Finishes:



SBN & MSN



BLK & 22K Gold



WC escutcheon

■ 6x6mm ■ 8x8mm



Yale escutcheon

Product dimensions

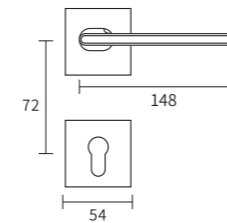

Key escutcheon



YOUR IISDOO  
HARDWARE



22K Matt Gold



Satin Black Nickel



Matt Black



WOOD DOORS  
LOCKS / HINGES



22K Matt Gold



Matt Satin Chrome



Matt Black

84283

Different configuration options

Material: Zinc alloy  
Suitable door thickness: 35-45mm  
Available Finishes:



WC escutcheon  
● 6x6mm ● 8x8mm



Yale escutcheon

Product dimensions

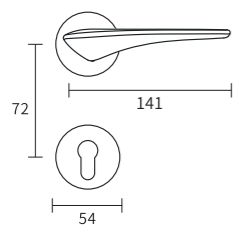

Key escutcheon

84288

Different configuration options

Material: Zinc alloy  
Suitable door thickness: 35-45mm  
Available Finishes:

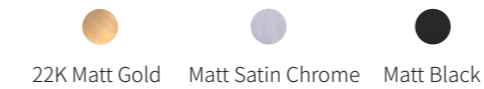

WC escutcheon  
● 6x6mm ● 8x8mm



Yale escutcheon

Product dimensions

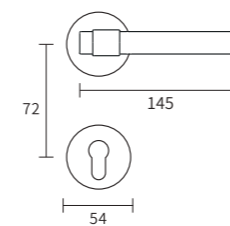

Key escutcheon



YOUR IISDOO  
HARDWARE



Matt Satin Chrome & Matt Black



Matt Satin Nickel  
& Satin Black Nickel



22K Matt Gold  
& Matt Black

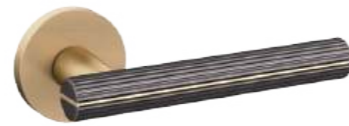

22K Matt Gold  
& Satin Black Nickel

# 84294

**Material:** Zinc alloy  
**Suitable door thickness:** 35-45mm  
**Available Finishes:**

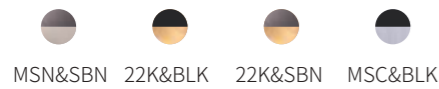

### Product dimensions

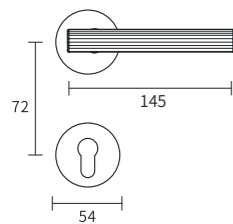

### Different configuration options



WC escutcheon  
● 6x6mm ● 8x8mm



Yale escutcheon



Key escutcheon



WOOD DOORS  
LOCKS / HINGES





YOUR IISDOO  
HARDWARE



Pearl Nickel & Matt Gold



Agate Grey & Matt Satin Nickel



Matt Gold & Matt White



WOOD DOORS  
LOCKS / HINGES



22K Matt Gold & White



Satin Black Nickel & Matt Satin Nickel

## 84312

### Different configuration options

**Material:** Zinc alloy  
**Suitable door thickness:** 35-45mm  
**Available Finishes:**

- Pearl Nickel & Matt Gold
- Agate Grey & Matt Satin Nickel
- Matt Gold & Matt White

### Product dimensions

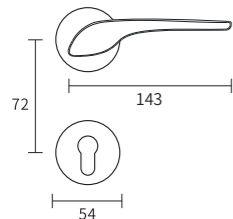

WC escutcheon  
● 6x6mm ● 8x8mm



Yale escutcheon



Key escutcheon

## 84334

### Different configuration options

**Material:** Zinc alloy  
**Suitable door thickness:** 35-45mm  
**Available Finishes:**

- 22K & White
- SBN & MSN

### Product dimensions

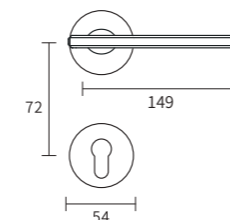

WC escutcheon  
● 6x6mm ● 8x8mm



Yale escutcheon



Key escutcheon

IISDOO®

YOUR IISDOO  
HARDWARE



IISDOO®

WOOD DOORS  
LOCKS / HINGES



Matt Black & Matt Satin Chrome



22K Matt Gold & Matt Black



Matt Black & 22K Matt Gold

89316

**Material:** Zinc alloy  
**Suitable door thickness:** 35-45mm  
**Available Finishes:**

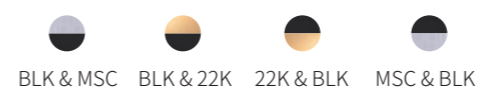

**Product dimensions**

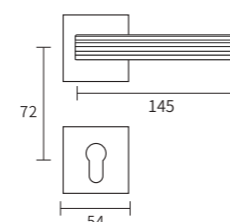

**Different configuration options**



WC escutcheon

■ 6x6mm ■ 8x8mm



Yale escutcheon



Key escutcheon



YOUR IISDOO  
HARDWARE

# No.2

## ALUMINUM WOOD DOOR HARDWARE SERIES /

The aluminum-wood door represents the perfect marriage of contemporary engineering and natural elegance. IISDOO's dedicated hardware series is precision-engineered for this unique union, ensuring that every component not only meets but enhances the door's dual character—offering enduring performance while complementing its sophisticated aesthetic.

Engineered for the Hybrid Structure

**Material Harmony:** Our hardware is designed to create a seamless visual and functional bridge between the sleek, sturdy aluminum frame and the warm, organic wood panel.

**Precision Fit & Finish:** We offer specialized fittings and a curated selection of finishes—from modern Matt Black and Brushed Nickel to classic Polished Brass—that align perfectly with both aluminum's cool luster and wood's rich grain.

**Adaptive Performance:** Each product, from hinges to handles and locks, is developed to accommodate the specific weight, movement, and expansion characteristics of composite aluminum-wood doors.

The Hardware That Honors the Craft

From sleek, minimalist handles that accentuate modern lines to robust concealed hinges that maintain a clean profile, our series provides cohesive solutions. We ensure that the hardware performs flawlessly as the functional interface of the door, while acting as the refined detail that completes its high-end statement.



WOOD DOORS  
LOCKS / HINGES



[www.iisdoodesign.com](http://www.iisdoodesign.com)



YOUR IISDOO  
HARDWARE



WOOD DOORS  
LOCKS / HINGES



Surface-mounted / Concealed Cylinder

F Series / Y Series

## FUNCTION INTRODUCTION OF MINIMALIST DOOR LOCK





YOUR IISDOO  
HARDWARE



WOOD DOORS  
LOCKS / HINGES

**Minimalist & Elegant Design**

Concealed Decorative  
Cover & Hidden Screws

- 1. Emergency Access: Concealed keyhole for quick emergency unlock
- 2. Universal Fit: Reversible lever – fits left or right-hand doors
- 3. Enhanced Durability: Anti-prying design; lever depresses when locked for longer life
- 4. Flexible Installation: Surface or concealed mounting; passage & bathroom functions



**Minimalist & Elegant Design**

Concealed Decorative  
Cover & Hidden Screws

Customizable Finishes:  
Multiple decorative options to match any style

IISDOO®

YOUR IISDOO  
HARDWARE



IISDOO®

WOOD DOORS  
LOCKS / HINGES



## 262F-C

**Material:** Zinc alloy  
**Suitable for door thickness:** 40-60mm  
**Application:** Bathroom with BK, Entry with KEY  
**Application Scope:**  
Wooden door, Aluminum wooden door

### Product dimensions

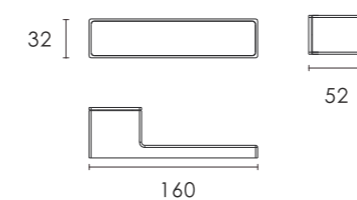

Matt White



Matt White



Matt black



Matt black



Platinum grey



Platinum grey

IISDOO®

YOUR IISDOO  
HARDWARE



IISDOO®

WOOD DOORS  
LOCKS / HINGES



## 262Y-C

**Material:** Zinc alloy  
**Suitable for door thickness:** 40-60mm  
**Application:** Bathroom with BK, Entry with KEY  
**Application Scope:**  
Wooden door, Aluminum wooden door

### Product dimensions

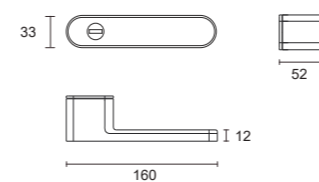

The IISDOO logo consists of the brand name in a clean, sans-serif font, with a registered trademark symbol. To the right of the logo, there is a decorative graphic of a black line with several small, glowing white circles, resembling a modern lighting fixture.

IISDOO®

YOUR IISDOO  
HARDWARE

The IISDOO logo is identical to the one in the top left, featuring the brand name and a decorative lighting graphic.

IISDOO®

WOOD DOORS  
LOCKS / HINGES

A photograph of a modern interior space. The wall is covered in vertical wood panels with a natural grain. A door, also made of wood, is perfectly flush with the wall, creating a seamless transition. The floor is made of light-colored wood planks. On the left, there is a small potted tree and a dark metal railing. The lighting is soft and even, highlighting the textures of the wood.

## HIDDEN DOORS HARDWARE SERIES /

With IISDOO's hidden door lock system, concealed doors achieve flawless alignment and seamless integration between doors and walls, elevating the overall aesthetics of any space. Paired with invisible hydraulic hinges, the door glides shut smoothly and quietly — even without an external handle — ensuring both safety and minimalist appeal.

The hidden door handle is thoughtfully designed with clean, modern lines that complement contemporary interiors. It features an emergency unlock function for added security and peace of mind. What's more, the decorative cover plate is fully customizable in a variety of colors and finishes, allowing for perfect coordination with wall surfaces or design themes — making every hidden door not just functional, but a true design element.

IISDOO®

YOUR IISDOO  
HARDWARE



IISDOO®

WOOD DOORS  
LOCKS / HINGES



## B262F / Y-C

**Material:** Zinc alloy  
**Suitable for door thickness:** 48-60mm  
**Application Scope:**  
Wooden door, Aluminum wooden door

### Product dimensions

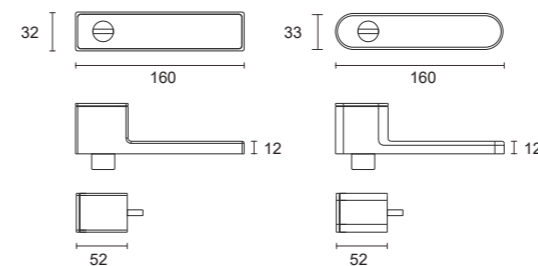

Matt White



Matt White



Matt black



Matt black



Platinum grey



Platinum grey

IISDOO®

YOUR IISDOO  
HARDWARE

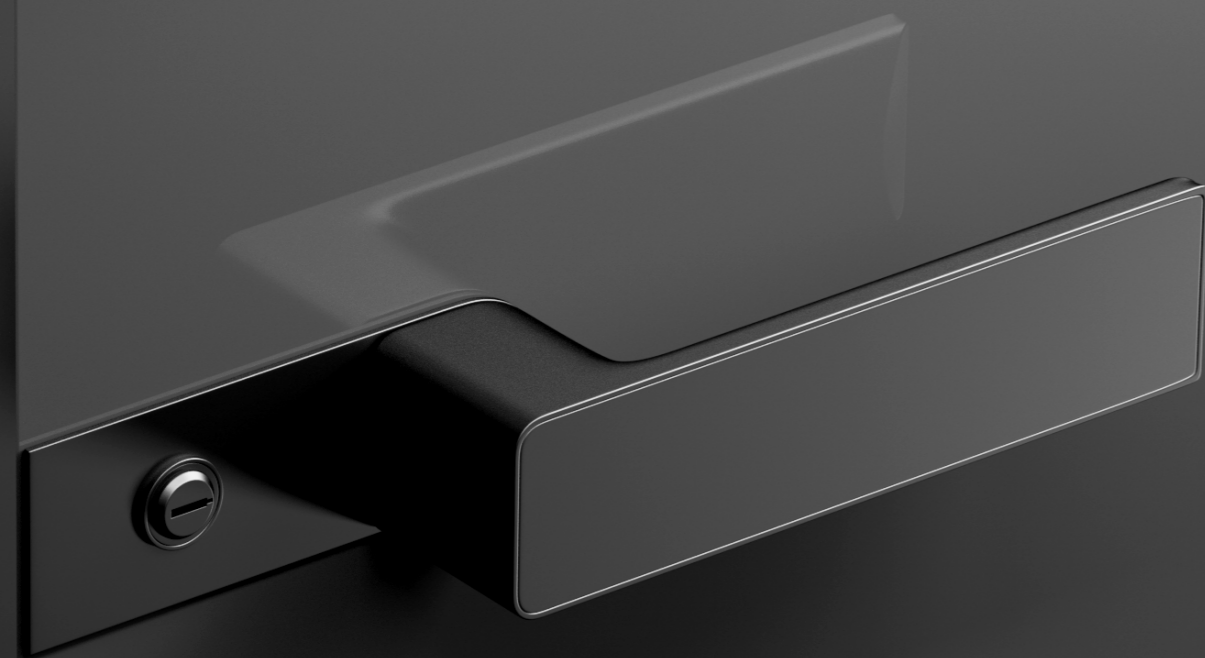

IISDOO®

WOOD DOORS  
LOCKS / HINGES



## B259

**Material:** Zinc alloy

**Suitable for door thickness:** 45-55mm

**Application:** Bathroom with BK, Entry with KEY

**Application Scope:**

Wooden door, Aluminum wooden door

### Product dimensions

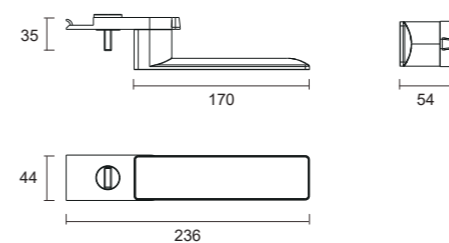

Matt black

IISDOO®

YOUR IISDOO  
HARDWARE



IISDOO®

WOOD DOORS  
LOCKS / HINGES



## B272F-C

**Material:** Aluminum

**Suitable for door thickness:** 40-60mm

**Application:** Bathroom with BK, Entry with KEY

**Application Scope:**

Wooden door, Aluminum wooden door

### Product dimensions

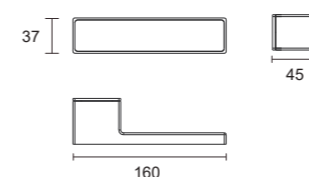

Matt White



Matt black



Platinum grey



YOUR IISDOO  
**HARDWARE**

# No.3

## **GLASS DOOR WITH SLIM ALUMINUM FRAME HARDWARE SERIES /**

Thanks to our strong production capacity and advanced manufacturing capabilities, IISDOO offers flexible customization of rosettes to accommodate a wide variety of aluminum profile shapes and specifications — ensuring a perfect fit for every unique door design. In addition, we are able to achieve precise and seamless color matching between the door lock and the aluminum frame, a critical detail — especially for glass doors with slim aluminum frames, where visual harmony and clean lines are essential to the overall aesthetic.

With extensive experience in the industry, IISDOO has developed mature and reliable solutions specifically tailored for glass doors with slim aluminum frames. Whether dealing with standard profiles or complex custom designs, our team is able to respond quickly and efficiently — providing professional, ready-to-implement solutions that meet both technical requirements and design expectations. This ensures that every project not only functions flawlessly but also maintains a sleek, cohesive appearance from door handle to frame.



WOOD DOORS  
**LOCKS / HINGES**



[www.iisdoodesign.com](http://www.iisdoodesign.com)

IISDOO®

YOUR IISDOO  
HARDWARE



IISDOO®

WOOD DOORS  
LOCKS / HINGES



**Double-frame ultra-narrow glass door**



**Single-frame ultra-narrow glass door**

**Frameless ultra-narrow glass door**



YOUR IISDOO  
HARDWARE



WOOD DOORS  
LOCKS / HINGES

Customizable Spacer  
Plate for Glass Doors

- 1. Emergency Access: Concealed keyhole for quick emergency unlock.
- 2. Universal Fit: Reversible lever – fits left or right-hand doors.
- 3. Enhanced Durability: Anti-prying design; lever depresses when locked for longer life.
- 4. Flexible Installation: Surface or concealed mounting; passage & bathroom functions.

Zinc Alloy

Minimalist & Elegant Design  
Concealed Decorative Cover  
& Hidden Screws

Minimalist & Elegant Design  
Concealed Decorative Cover  
& Hidden Screws

Customizable Finishes:  
Multiple decorative options to match any style

IISDOO®

YOUR IISDOO  
HARDWARE



IISDOO®

WOOD DOORS  
LOCKS / HINGES



**SINGLE-FRAME  
ULTRA-NARROW GLASS DOOR  
HARDWARE SERIES /**

IISDOO®

YOUR IISDOO  
HARDWARE



IISDOO®

WOOD DOORS  
LOCKS / HINGES



**FRAMELESS  
ULTRA-NARROW GLASS DOOR  
HARDWARE SERIES /**



YOUR IISDOO  
HARDWARE

**DOUBLE-FRAME  
ULTRA-NARROW GLASS DOOR  
HARDWARE SERIES /**



WOOD DOORS  
**LOCKS / HINGES**



**BD262F-C**

**Material:** Zinc alloy + aluminum

**Suitable for door thickness:** 8-12mm

**Application:** Bathroom with BK, Entry with KEY

**Application Scope:**

Double-frame ultra-narrow glass door

Single-frame ultra-narrow glass door

Frameless ultra-narrow glass door

**Product dimensions**

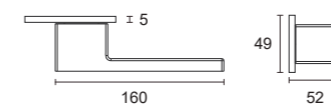
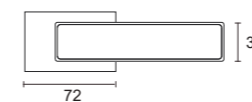

Matt White



Matt White



Matt black



Matt black



Platinum grey



Platinum grey

IISDOO®

YOUR IISDOO  
HARDWARE

**DOUBLE-FRAME  
ULTRA-NARROW GLASS DOOR  
HARDWARE SERIES /**



IISDOO®

WOOD DOORS  
LOCKS / HINGES



## BDW269

**Material:** Zinc alloy + aluminum  
**Suitable for door thickness:** 8-12mm  
**Application:** Bathroom with indicator  
**Application Scope:**  
Double-frame ultra-narrow glass door

### Product dimensions

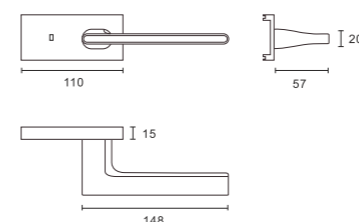

Matt black



YOUR IISDOO  
HARDWARE

**DOUBLE-FRAME  
ULTRA-NARROW GLASS DOOR  
HARDWARE SERIES /**



WOOD DOORS  
**LOCKS / HINGES**



**BD292**

**Material:** Aluminum  
**Suitable for door thickness:** 8-12mm  
**Application:** Bathroom with BK, Entry with KEY  
**Application Scope:**  
Double-frame ultra-narrow glass door

**Product dimensions**

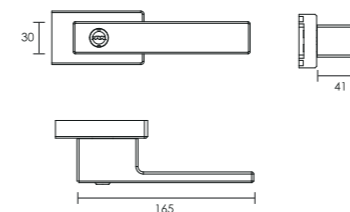

Matt black



Silver



Matt White

# No.4

## Door Hardware Practical & Minimalist

High-end Whole-house Multifunctional  
Door Hardware Solutions

- / **Aluminum-Wood Composite Door**  
Door Hardware Solutions
- / **Aluminum Frame Glass Door**  
Door Hardware Solutions
- / **Frameless Glass Door (Double-sided)**  
Door Hardware Solutions





YOUR IISDOO  
HARDWARE

# WOODEN DOORS HARDWARE SERIES /



Our state-of-the-art Door Hardware Manufacturing Facility is powered by a dedicated team of approximately 100 employees, including 6 R&D specialists and 5 technical engineers driving continuous innovation. A rigorous 20-person quality management team maintains uncompromising standards throughout every production stage.

Spanning approximately 8,000 square meters, our facility is equipped with advanced production machinery designed for precision and efficiency. Key equipment includes 4 high-pressure die-casting machines and 15 automated polishing machines, ensuring flawless finishes across our entire product range — including door handles, door stops, concealed hinges, and more.

With an annual production capacity of roughly 2 million units of 3D adjustable concealed hinges, all our products comply with the EN1935 standard, meeting rigorous European requirements for performance, safety, and durability.

To guarantee consistent quality, the factory is outfitted with specialized QA equipment, including cycle testing machines that simulate years of repeated use, and salt spray test chambers for corrosion resistance evaluation. These tools validate functional performance and structural integrity before products reach the market.

This infrastructure supports stringent daily quality control and reinforces our commitment to manufacturing high-performance, industry-compliant door hardware for global applications. At IISDOO — from smooth hinges to ergonomic handles — every product reflects our dedication to precision, durability, and design excellence.



WOOD DOORS  
LOCKS / HINGES





YOUR IISDOO  
HARDWARE

### S-type double-axis hydraulic hinge

**Material:** Zinc alloy/aluminum alloy

**Opening angle:** 180°

**Product load-bearing capacity:** 80KG/pair

**Applicable scenarios:**  
invisible door, aluminum-wood door, wooden door

**Cycle test:** 300,000 times

**Functional Angles:**

180°-80°: Free-Swing Zone

80°-30°: Quick-Closing Zone

(WithLock) 30°-15°: Slow Close,

15°-0°: Pressure Release & Quick Lock

(Silent) 30°-0°: Slow Close:

**2D/3D Adjustment Range:**

Vertical: +2.5mm Horizontal: +2mm

**Available Finish:**



Matt Black



Sliver



Matt White

### Product dimensions

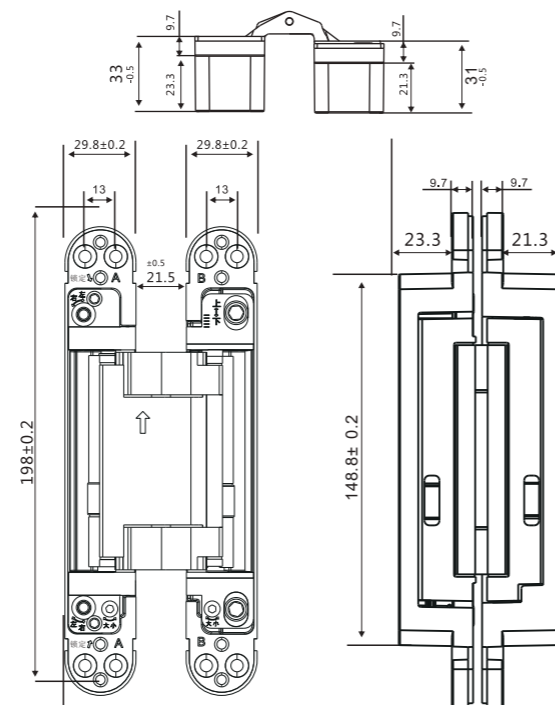

1. Load Capacity: 40kg per hinge

2. Suitable for: Wooden doors, concealed doors

Number of hinges determined by door weight and dimensions

| Door weight | Dimension Height x width | Number of hinges used |
|-------------|--------------------------|-----------------------|
| ≤ 80 kg     | ≤ 2100 x 800mm           | 2 hydraulic           |
| ≤ 80 kg     | ≤ 2300 x 900mm           | 2 hydraulic + 1 dummy |
| ≤ 100 kg    | ≤ 2400 x 1000mm          | 3 hydraulic           |



WOOD DOORS  
LOCKS / HINGES





YOUR IISDOO  
HARDWARE

# AD6005

## 3D Concealed Hydraulic Hinge

**Material:** Zinc alloy & Aluminum

**Suitable Door Thickness:** 35-60mm

**Handing Universal:** Left & Right Universal

**Installation Type:** Mill Installation

**3D Adjustment:**

Vertical:  $\pm 2\text{mm}$  / Depth:  $\pm 1\text{mm}$  / Horizontal:  $\pm 3\text{mm}$

**Applicable Door Types:**

doors with rebate, Aluminum Frame Doors, Wooden Doors

**Available Finish:**

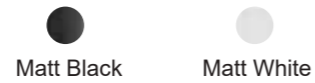

**Features:**

1. 28mm ultra-narrow  $\times$  10mm super-slim profile
2. For 45mm doors with rebate, a 4mm door edge margin can be maintained
3. Shallow door frame mortising prevents damage to internal aluminum frame structure, ensuring stronger door frame integrity
4. Fully concealed design; seamless integration via Mill installation
5. Hydraulic buffering with integrated damping mechanism
6. 3D adjustable for precise and effortless alignment
7. Adjustable damping rate for full control over closing speed
8. 110° opening angle with automatic, silent self-closing
9. Exceptional load-bearing capacity: 2 hinges support up to 70KG

**Product dimensions**

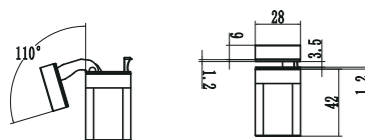
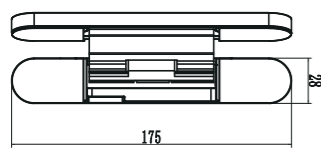
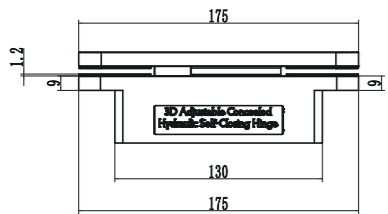

WOOD DOORS  
LOCKS / HINGES

Door Frame Mill Width  
28.5mm

Door Leaf Mill Width  
28.5mm

Backset  
4mm



Door Frame Mill Depth  
10.5mm

Door Leaf Mill Depth  
10.5mm

Door Leaf Mill Length  
175mm

Door Leaf Mill Depth  
43.5mm



YOUR IISDOO  
HARDWARE



WOOD DOORS  
LOCKS / HINGES



### Heavy-Duty Hinge

Non-Hydraulic Heavy-Duty Hinge  
Installed at the top of the door  
Bears the majority of the door's weight  
Ensures the proper operation of  
the hydraulic hinges below

### Hydraulic Hinge

Features a built-in smooth  
self-closing hydraulic mechanism  
Equipped with a built-in 90° hold-open function  
When two hydraulic hinges are used together  
Maximum load capacity: 80kg



### Product dimensions

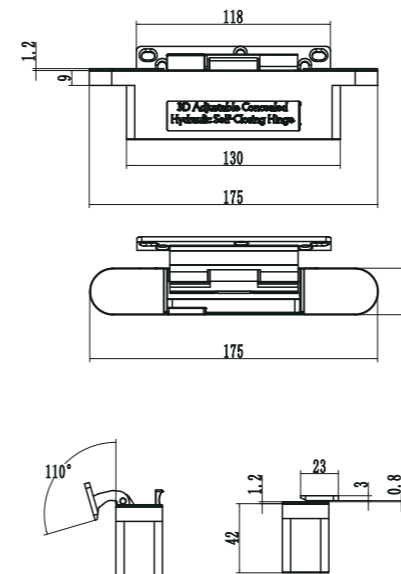

# AM6005

## 3D Concealed Hydraulic Hinge

**Material:** Zinc alloy & Aluminum

**Suitable Door Thickness:** 35-60mm

**Handing Universal:** Left & Right Universal

**Installation Type:** Mill-Free Installation

### 3D Adjustment:

Vertical:  $\pm 2\text{mm}$  / Depth:  $\pm 1\text{mm}$  / Horizontal:  $\pm 3\text{mm}$

### Applicable Door Types:

doors with rebate, Aluminum Frame Doors, Wooden Doors

### Available Finish:



### Features:

- 1.28mm ultra-narrow  $\times$  10mm super-slim profile
2. For 45mm doors with rebate, a 4mm door edge margin can be maintained
3. Shallow door frame mortising prevents damage to internal aluminum frame structure, ensuring stronger door frame integrity
4. Fully concealed design; seamless integration via Mill installation
5. Hydraulic buffering with integrated damping mechanism
6. 3D adjustable for precise and effortless alignment
7. Adjustable damping rate for full control over closing speed
8. 110° opening angle with automatic, silent self-closing
9. Exceptional load-bearing capacity: 2 hinges support up to 70KG

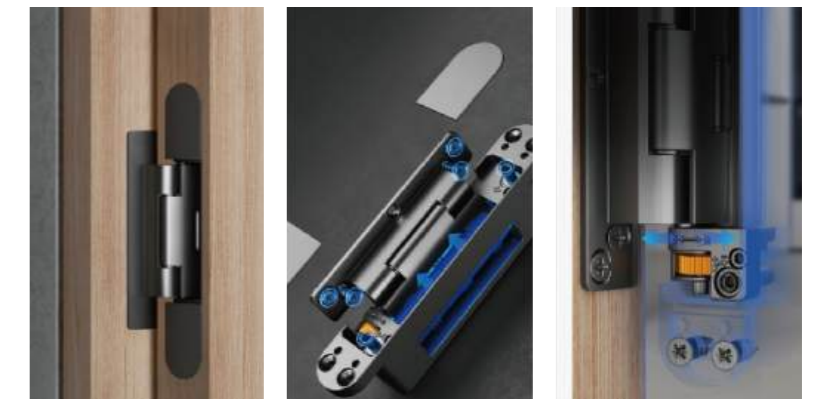



YOUR IISDOO  
HARDWARE



WOOD DOORS  
LOCKS / HINGES



### 5-inch Hydraulic Hinge

**Material:** aluminum alloy

**Opening angle:** 180°

**Product load-bearing capacity:** 55KG/pair

**Applicable scenarios:**

invisible door, aluminum-wood door, wooden door

**Cycle test:** 300,000 times

**Functional Angles:**

180°-80°: Free-Swing Zone

80°-30°: Quick-Closing Zone

30°-0° Soft Closing Zone

**Available Finish:**



Matt Black

#### Product dimensions

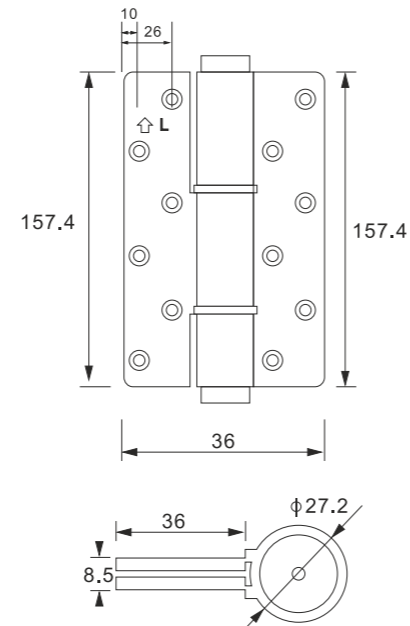

1. Load Capacity: 40kg per hinge

2. Suitable for: Wooden doors, concealed doors

Number of hinges determined by door weight and dimensions

| Door weight | Dimension Height x width | Number of hinges used |
|-------------|--------------------------|-----------------------|
| ≤ 55 kg     | ≤ 2000 x 900mm           | 2 hydraulic           |
| ≤ 90 kg     | ≤ 2400 x 1100mm          | 2 hydraulic           |





### YLS-033

**Material:**Zinc alloy  
**Application:** Wooden door  
**Opening degree:**180  
**Max bearing:**80KG/2 pieces  
**Door thickness:**40-60mm  
**Wdth of door:**less than 900mm  
**Height of door:**less than 2300mm

**Adjustment**  
**Horizontal :**± 3mm  
**Vertical:**-2mm,+4mm  
**Pressure:**±1mm  
**Finish:**

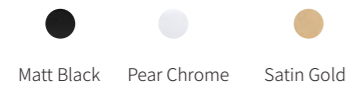

**Size:**

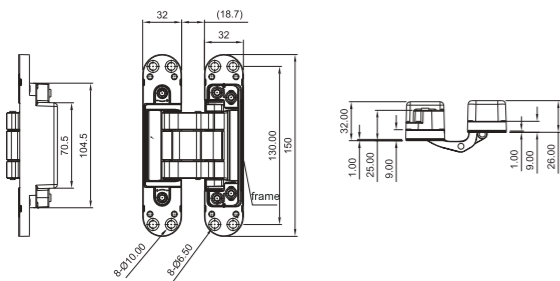

### YLS-034

**Material:**Zinc alloy  
**Application:** Wooden door  
**Opening degree:**180  
**Max bearing:**30KG/2 pieces  
**Door thickness:**≥29mm  
**Wdth of door:**less than 900mm  
**Height of door:**less than 2400mm

**Adjustment**  
**Horizontal :**± 2.5mm  
**Vertical:**+2mm  
**Pressure:**±1mm  
**Finish:**

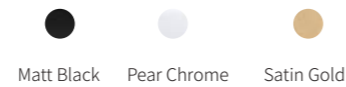

**Size:**

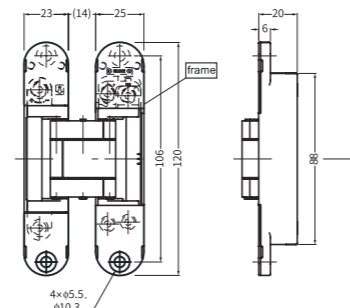

### YLS-035

**Material:**Zinc alloy  
**Application:** Wooden door  
**Opening degree:**180  
**Max bearing:**50KG/2 pieces  
**Door thickness:**35-45mm  
**Wdth of door:**less than 900mm  
**Height of door:**less than 2100mm

**Adjustment**  
**Horizontal :**± 2mm  
**Vertical:**-2mm,+3mm  
**Pressure:**±1mm  
**Finish:**

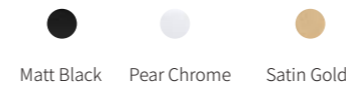

**Size:**

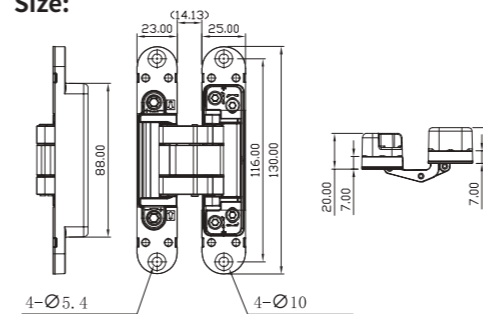

### YLS-036

**Material:**Zinc alloy  
**Application:** Wooden door  
**Opening degree:**180  
**Max bearing:**60KG/2 pieces  
**Door thickness:**38-55mm  
**Wdth of door:**less than 900mm  
**Height of door:**less than 2100mm

**Adjustment**  
**Horizontal :**± 2mm  
**Vertical:**+2mm  
**Pressure:**±1mm  
**Finish:**



**Size:**

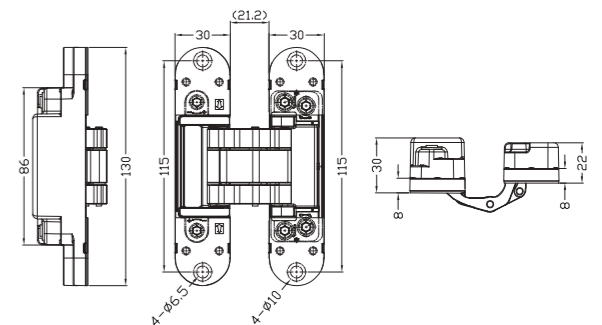



YOUR IISDOO  
HARDWARE



### YLS-074

**Material:**Zinc alloy  
**Application:**Zinc alloy Wooden door,  
Wooden aluminum door For flush door with  
rebate or without rebate

**Opening degree:**180  
**Max bearing:**40KG/PAIR  
**Door thickness:**37-55mm  
**Wdth of door:**less than 900mm  
**Height of door:**less than 2100mm  
**Adjustment**  
**Horizontal :**± 1.5mm  
**Vertical:**± 2mm  
**Pressure:**± 1mm  
**Finish:**

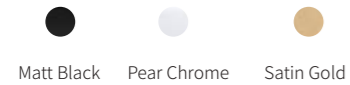

**Size:**

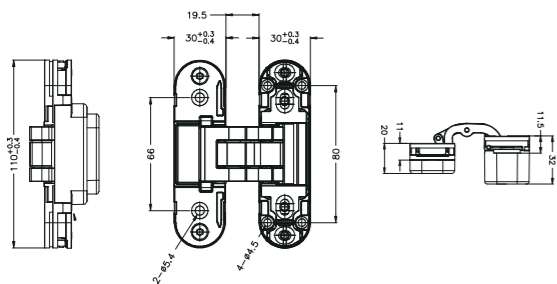

### YLS-075

**Material:**Zinc alloy  
**Application:**Zinc alloy Wooden door,  
Wooden aluminum door For flush door with  
rebate or without rebate

**Opening degree:**180  
**Max bearing:**40KG/PAIR  
**Door thickness:**30-45mm  
**Wdth of door:**less than 900mm  
**Height of door:**less than 2100mm  
**Adjustment**  
**Horizontal :**± 2mm  
**Vertical:**± 2mm  
**Pressure:**± 1mm  
**Finish:**

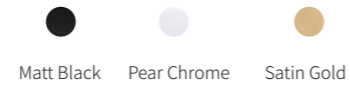

**Size:**

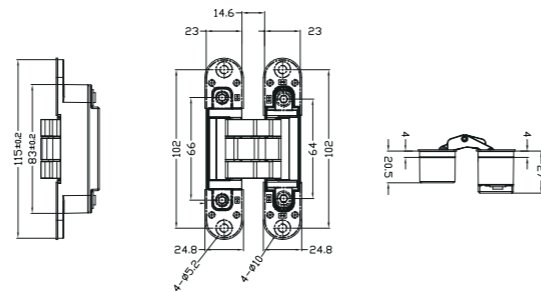

WOOD DOORS  
LOCKS / HINGES



### YLS-077

**Material:**Zinc alloy  
**Application:**Zinc alloy Wooden door,  
Wooden aluminum door For flush door with  
rebate or without rebate

**Opening degree:**180  
**Max bearing:**80KG/2 pieces  
**Door thickness:**38-50mm  
**Wdth of door:**less than 900mm  
**Height of door:**less than 2100mm  
**Adjustment**  
**Horizontal :**± 4mm, -2mm  
**Vertical:**± 3mm  
**Pressure:**± 1mm  
**Finish:**

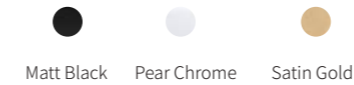

**Size:**

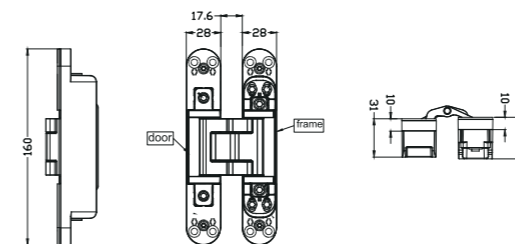

### YLS-080

**Material:**Zinc alloy  
**Application:**Zinc alloy Wooden door,  
Wooden aluminum door For flush door with  
rebate or without rebate

**Opening degree:**180  
**Max bearing:**50KG/2 pieces  
**Door thickness:**38-55mm  
**Wdth of door:**less than 900mm  
**Height of door:**less than 2100mm  
**Adjustment**  
**Horizontal :**± 3.5mm, -2mm  
**Vertical:**± 2mm  
**Pressure:**± 1mm  
**Finish:**

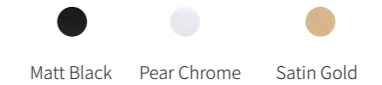

**Size:**

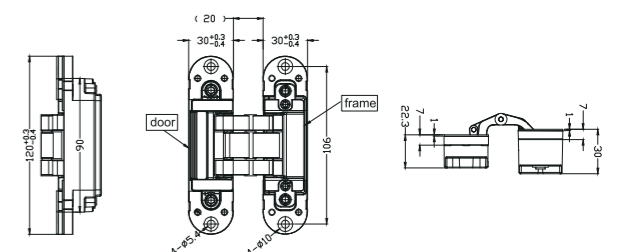





YOUR IISDOO  
HARDWARE



### YLS-Z01

**Material:** Zinc Alloy / Stainless steel  
**Application:** Wooden aluminum door , Glass Door  
**Opening degree:** 110°  
**Max bearing:** 50KG/PAIR  
**Door thickness:**38-55mm  
**Wdth of door:**less than 900mm  
**Height of door:**less than 2100mm  
**Adjustment Horizontal:**+ 1.5mm  
**Vertical:**+ 2mm  
**Pressure:**+1mm  
**Available Finish:**



**Size:**

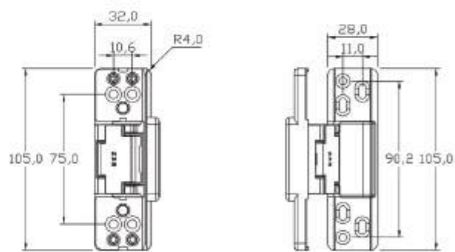

### YLS-Z02

**Material:** Zinc Alloy / Stainless steel  
**Application:** Wooden aluminum door , Wooden Door  
**Opening degree:** 110°  
**Max bearing:** 80KG/PAIR  
**Door thickness:**38-55mm  
**Wdth of door:**less than 914mm  
**Height of door:**less than 2000mm  
**Adjustment Horizontal:**+ 1.5mm  
**Vertical:**+ 2mm  
**Pressure:**+1mm  
**Available Finish:**



**Size:**

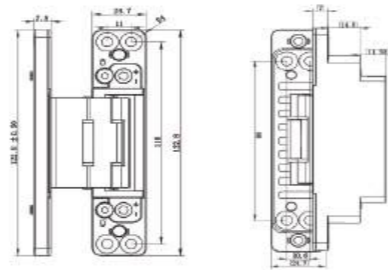

WOOD DOORS  
LOCKS / HINGES



### 4-inch Butt Hinge

**Material:** SS304 / SS201  
**Application:** Wooden aluminum door, Wooden Door  
**Opening degree:**180°  
**Max bearing:** 40KG / PAIR  
**Door thickness:** 38-55mm  
**Wdth of door:** less than 900mm  
**Height of door:** less than 1950mm  
**Main Specification:**  
4"x3"x2.5mmx2BB  
4"x 3"x3mmx2BB  
**Available Finish:** ● Stainless steel

**Size:**

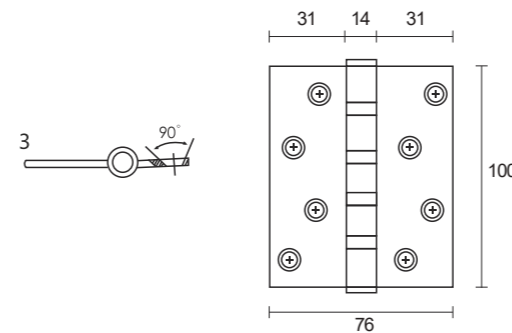

### 5-inch Butt Hinge

**Material:** SS304 / SS201  
**Application:** Wooden aluminum door, Wooden Door  
**Opening degree:**180°  
**Max bearing:** 40KG / PAIR  
**Door thickness:** 38-55mm  
**Wdth of door:** less than 900mm  
**Height of door:** less than 1950mm  
**Main Specification:**  
5"x 3"x3mmx2BB  
**Available Finish:** ● Stainless steel

**Size:**

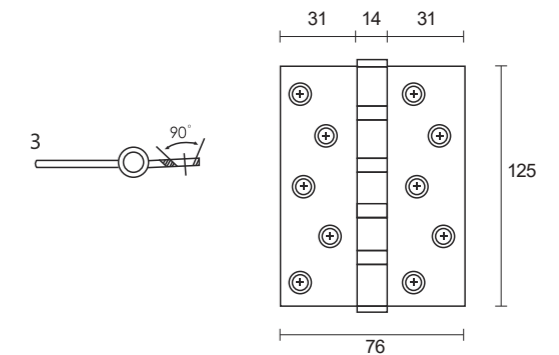



YOUR IISDOO  
HARDWARE





WOOD DOORS  
LOCKS / HINGES



### YLS-940 Door stopper

Main material: ABS & Steel

Finish:  Matt Black  Pear Chrome  Satin Gold

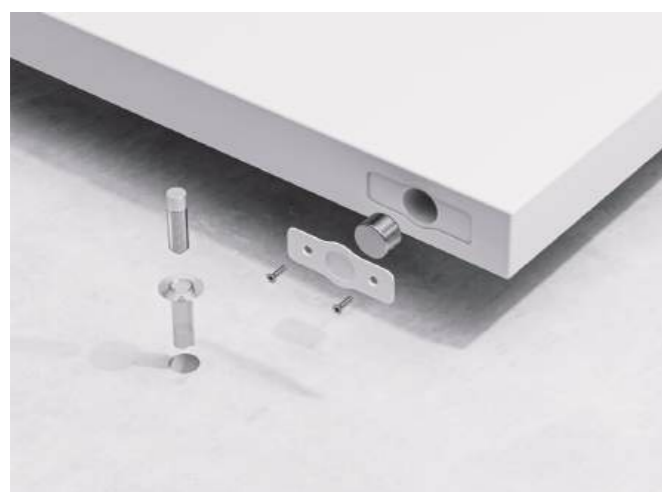
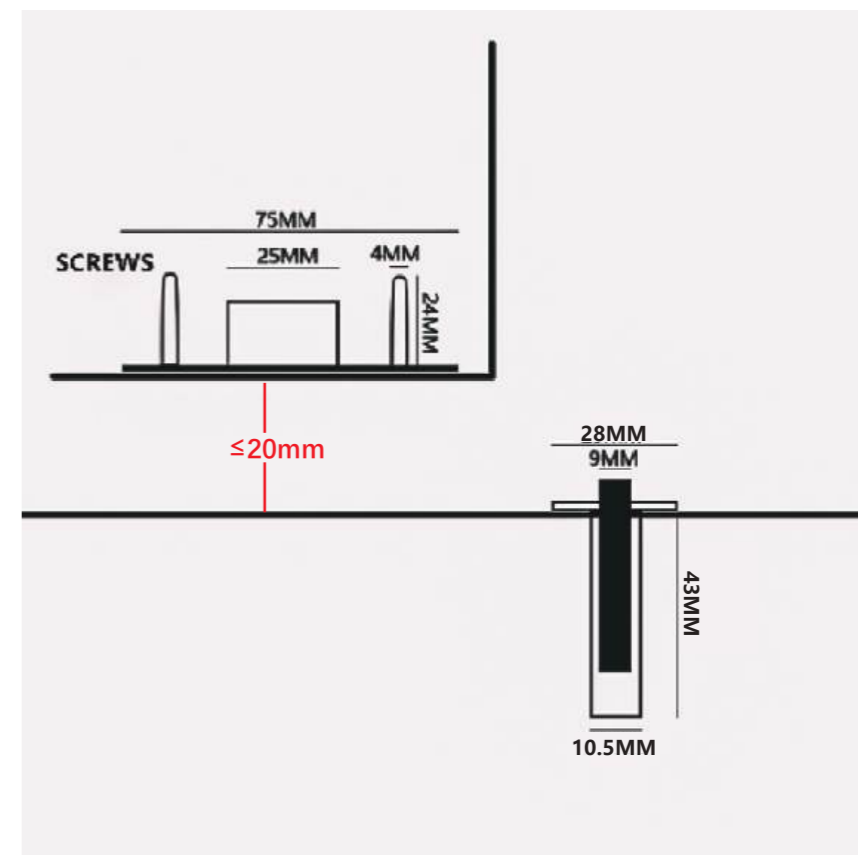
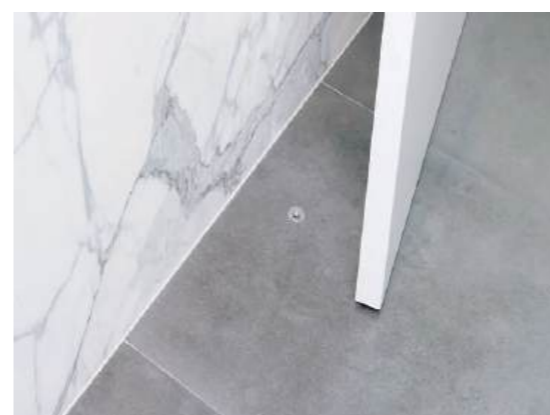
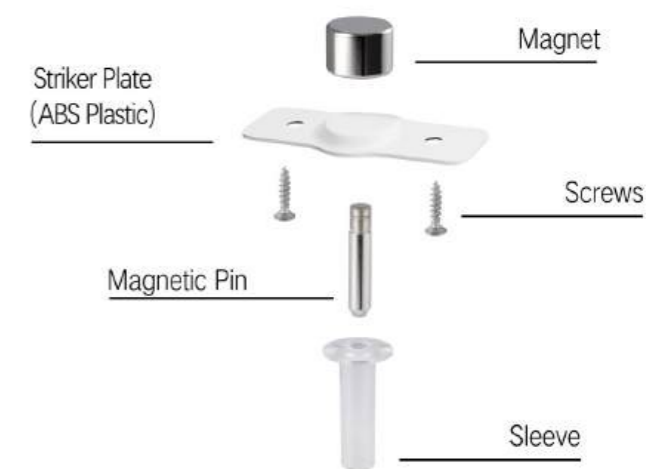
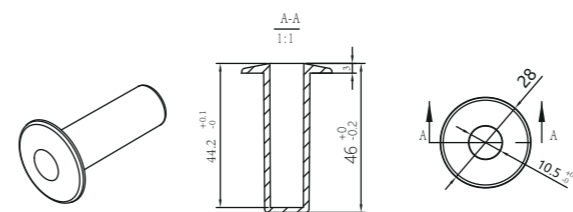



YOUR IISDOO  
HARDWARE



WOOD DOORS  
LOCKS / HINGES

## 907 Wooden Door Stopper

**Material:** Zinc Alloy

**Size:**

Door Stopper: 39\*20\*36

Base Size: 39\*30\*7

**Available Finish:**



Matt White



Matt Black

### Product dimensions

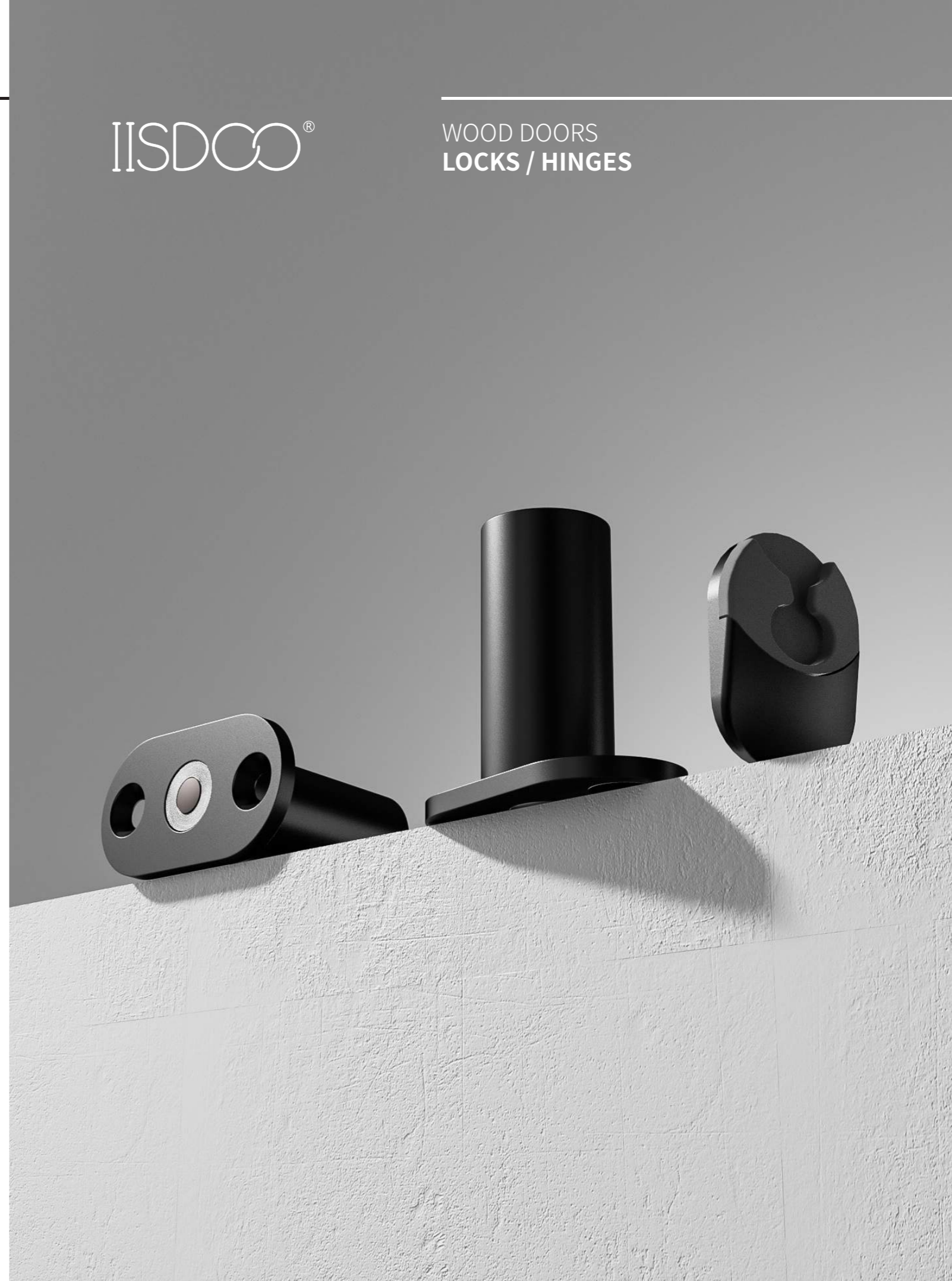
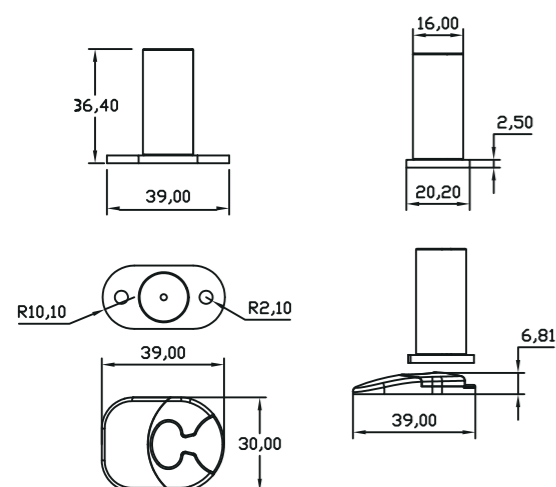

IISDOO®

YOUR IISDOO  
HARDWARE

IISDOO's magnetic glass door stop is meticulously engineered for modern narrow-frame glass door systems, combining minimalist aesthetics with robust functionality. Designed for quick and convenient installation, it delivers reliable performance while preserving the clean, seamless look of contemporary interiors.

**Powerful Magnetic Suction:** Utilizing high-grade permanent magnets, the stop securely holds glass doors in place—even in breezy environments or high-traffic areas—with a simple "push-to-lock" mechanism that ensures stable, wobble-free positioning.

**Quick & Effortless Installation:** Engineered for fast, tool-friendly mounting, the door stop requires no complicated drilling or specialized labor. This saves time, reduces installation complexity, and avoids damage to walls or floor surfaces.

IISDOO®

WOOD DOORS  
LOCKS / HINGES

## 906 Glass Door Stopper

**Material:** Zinc Alloy

**Size:**

Door Stopper: 39\*20\*36

Base Size: 39\*30\*7

**Available Finish:**



Matt White



Platinum grey



Matt Black



### Product dimensions

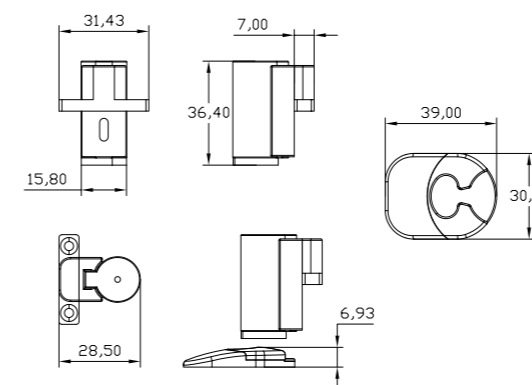



### Ultra-Slim 2D Adjustable Hinge

**Material:** Aluminum Alloy

**Finish:** Matt Black / Matt White

**Max bearing:** 35KG / PAIR

**Application:** Wooden door / Wooden aluminum door For flush door with rebate or without rebate / Frameless glass door

**Available Finish:**

● Matt Black

**Size:**

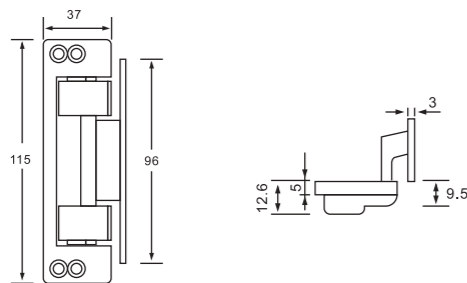

### Ultra-narrow Hinge

**Material:** Aluminum Alloy

**Opening degree:** 130°

**Max bearing:** 50KG / PAIR

**Width of door:** less than 900mm

**Height of door:** less than 2100mm

**Application:** Wooden door / Wooden aluminum door For flush door with rebate or without rebate / Frameless glass door

**Available Finish:**

● Matt Black

**Size:**

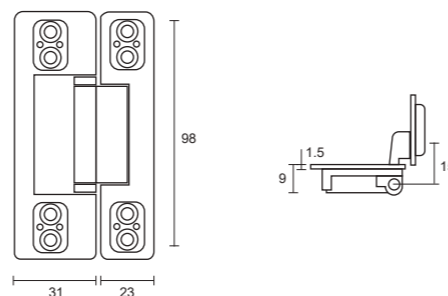

IISDOO®

YOUR IISDOO  
HARDWARE

GLASS  
DOOR



IISDOO®

WOOD DOORS  
LOCKS / HINGES



## Glass Door Clamp Kit

### Top Clamp

**Material:** Stainless Steel

**Suitable Glass Thickness:** 10-12mm

**Dimensions:** 160mm × 50mm × (Diameter) 12mm

### Curved Clamp

**Material:** Stainless Steel

**Suitable Glass Thickness:** 10-12mm

**Dimensions:** 215mm × 105mm × 50mm

### Overhead Clamp

**Material:** Stainless Steel

**Suitable Glass Thickness:** 10-12mm

**Dimensions:** 160mm × 50mm

### Bottom Clamp

**Material:** Stainless Steel

**Suitable Glass Thickness:** 10-12mm

**Dimensions:** 160mm × 50mm × Ø12mm





YOUR IISDOO  
HARDWARE



WOOD DOORS  
LOCKS / HINGES

Glass Door Patch Fitting (Top)



Floor Spring  
(No Groove / No Recess)



Top Pivot Plate

## No-Mill Floor Spring

**Material:** Stainless Steel Cover / Aluminum Alloy

**Suitable Glass Thickness:** 8-12mm

**Dimensions:** 190×70×42mm

**Max. Door Weight:** ≤120kg

**Max. Door Width:** ≤1000mm

## Floor Spring (No Groove / No Recess)

**Suitable door width:** ≤ 1000 mm

**Product load capacity:** ≤ 120 kg

**Application:** 8-12 mm frameless glass doors

**Product dimensions:** 190 × 70 × 42 mm

